



PU..X type flow control pressure compensated valves - 2 way

- Solenoid proportional type
- From SAE08 to SAE16 cavities

Technical specifications and diagrams are measured with mineral oil of 46 cSt viscosity at 40°C (104°F) temperature.

	PU08X	PU10X	PU12X	PU16X	
Nominal flow	10 l/min (2.6 US gpm)	30 l/min (7.9 US gpm)	50 l/min (13.2 US gpm)	90 l/min (23.8 US gpm)	
Max. pressure	315 bar (4600 psi)				
Oil leakage	at 210 bar 3050 psi	80 cm ³ /min (8.9 in ³ /min)	150 cm ³ /min (9.2 in ³ /min)	250 cm ³ /min (15.3 in ³ /min)	400 cm ³ /min (24.4 in ³ /min)
Fluid	mineral based oil				
Viscosity	10-200 cSt				
Max level of contamination	18/16/13 ISO4406				
Fluid temperature	with NBR seals with FPM seals	from -20°C (-4°F) to 80°C (176°F) from -20°C (-4°F) to 100°C (212°F)			
Environmental temp. for working conditions	from -20°C (-4°F) to 50°C (122°F)				
Cavity	SAE 08/2 A	SAE 10/2 A	SAE 12/2 A	SAE 16/2 A	
Coil type*	BH or BQP19				
Nominal voltages	12 VDC - 24V DC ± 10%				
Power rating	20.4 W (BH) - 15 W (BQP19)				
Max control current	12 V -> 1.70 A - 24 V -> 0.85 A (BH) 12 V -> 1.25 A - 24 V -> 0.63 A (BQP19)				
Dither frequency	150 Hz				
Hysteresis	8%				
Weight	0.34 kg (0.75 lb)	0.39 kg (0.86 lb)	0.51 kg (1.12 lb)	0.90 kg (1.98 lb)	

NOTE - For different conditions, please contact Walvoil Sales Dpt. - For coils further features see from page 206.

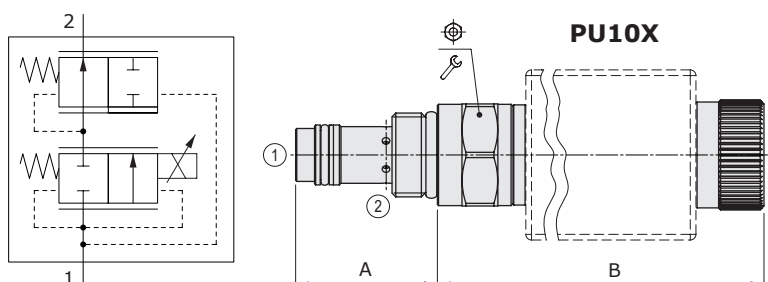

Valve type	A		B		⌀	⌀	Nm	lbf·ft
	mm	in	mm	in				
PU08X/A0N	36.6	1.44	94	3.70	24	30	22	
PU10X/A0N	37.5	1.48	96.4	3.79	27	50	37	
PU12X/A0N	58.5	2.30	97.4	3.83	32	75	55	
PU16X/A0N	68	2.68	121.4	4.78	41	95	70	

For dimensions with different type of emergency see page 213

Ordering codes and description composition

PU08X/A0NB

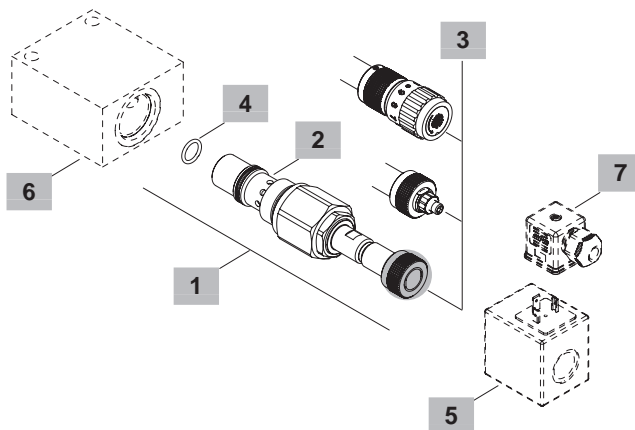
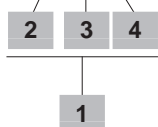

1 Cartridges

TYPE	CODE	DESCRIPTION
SAE cavity 08/2 A		
PU08X/A0NB	0PU08002012	Without emergency
PU08X/A0TB	0PU08002013	Screw type emergency
PU08X/A0VB	0PU08002014	Handknob emergency
SAE cavity 10/2 A		
PU10X/A0NB	0PU10002020	Without emergency
PU10X/A0TB	0PU10002021	Screw type emergency
PU10X/A0VB	0PU10002022	Handknob emergency
SAE cavity 12/2 A		
PU12X/A0NB	0PU12002007	Without emergency
PU12X/A0TB	0PU12002008	Screw type emergency
PU12X/A0VB	0PU12002009	Handknob emergency
SAE cavity 16/2 A		
PU16X/A0NB	0PU16002010	Without emergency
PU16X/A0TB	0PU16002011	Screw type emergency
PU16X/A0VB	0PU16002012	Handknob emergency

2 Pressure drop from 1 to 2

TYPE	DESCRIPTION
A	12 bar (170 psi)

3 Emergency

TYPE	DESCRIPTION
N	Without emergency
T	Screw type
V	Handknob

4 Seals

TYPE	DESCRIPTION
B	NBR (Buna) Std configuration without addition
V	For valve with FPM (Viton) o-ring seals, contact Sales Dept.

5 Coils

TYPE	CODE	DESCRIPTION
BQP19 12VDC	4SL5000126	12VDC-ISO4400 coil
BH 12VDC	4SLD001200	12VDC-ISO4400 coil

For complete coils list see from page 206

6 Valve body

TYPE	CODE	DESCRIPTION
SAE 08/2-G 3/8	3CC0820C11	Aluminium body for cavity 08 valve, G3/8 std thread
SAE 10/2-G 3/8	3CC1020C11	Aluminium body for cavity 10 valve, G3/8 std thread
SAE 12/2-G 1/2	3CC1220D11	Aluminium body for cavity 12 valve, G1/2 std thread
SAE 16/2-G 3/4	3CC1620E11	Aluminium body for cavity 16 valve, G3/4 std thread

Note: aluminium body can stand up to 210 bar (3050 psi)
For steel bodies or different threading see from page 215

7 Connector

TYPE	CODE	DESCRIPTION
ISO4400	4CN1009995	Connector

For complete connectors list see from page 206

PU08X: pressure compensation diagram 1→2
for % of control current

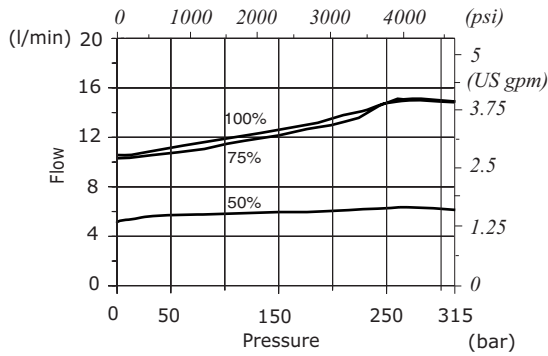

PU08X
flow regulating vs. % max. control current

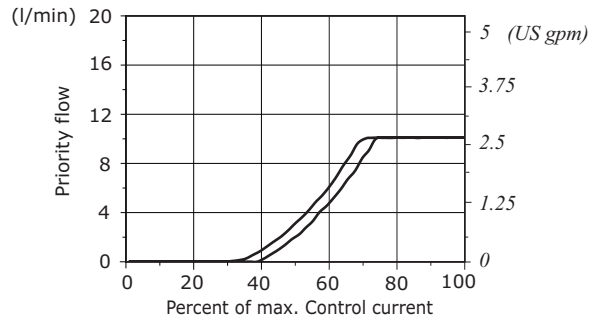

PU10X: pressure compensation diagram 1→2
for % of control current

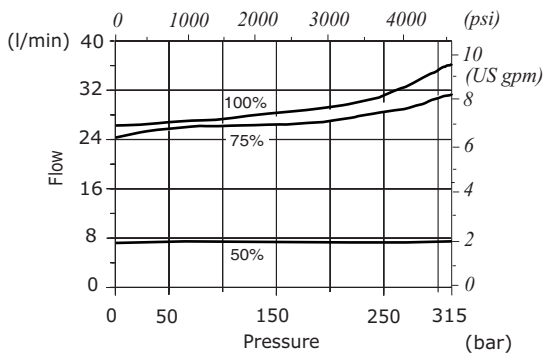

PU10X
flow regulating vs. % max. control current

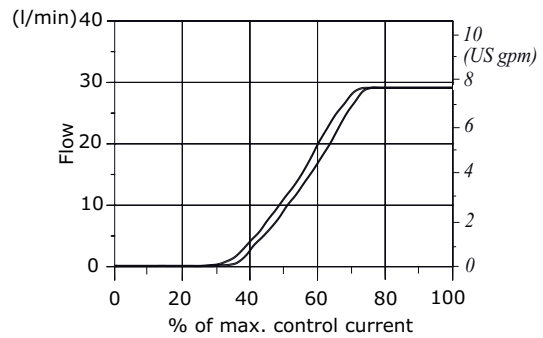

PU12X: pressure compensation diagram 1→2
for % of control current

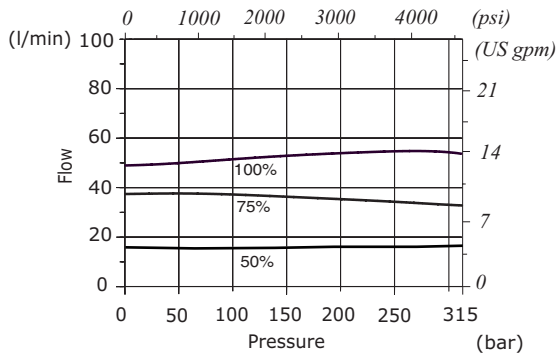

PU12X
flow regulating vs. % max. control current

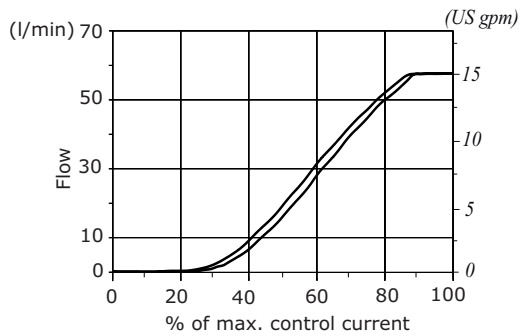

PU16X: pressure compensation diagram 1→2
for % of control current

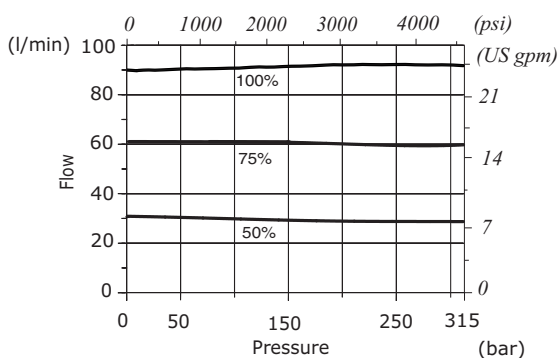

PU16X
flow regulating vs. % max. control current

